

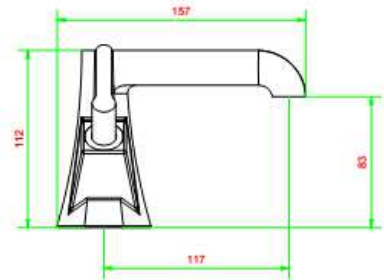

www.ibrubinetterie.it

BELMONDO ELLE
BL205

Range
Product

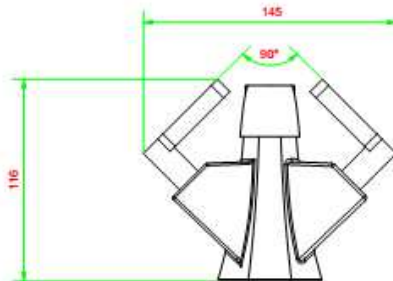
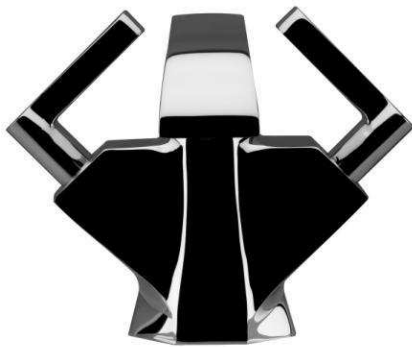

Product Description

Traditional mono hole washbasin mixer with the base integrated within the body as single-casted and metal levers. 1-1/4" click-clack automatic pop-up waste is included.

Available Finishings

Chrome	<input checked="" type="checkbox"/>	Glossy Black	<input type="checkbox"/>	PVD Gold	<input type="checkbox"/>	Copper	<input type="checkbox"/>
Brushed Nickel	<input checked="" type="checkbox"/>	Matt White	<input type="checkbox"/>	Gold	<input checked="" type="checkbox"/>	Bronze	<input type="checkbox"/>
Glossy White	<input type="checkbox"/>	Matt Black	<input type="checkbox"/>	Rose Gold	<input checked="" type="checkbox"/>	YO - Your Own	<input checked="" type="checkbox"/>

Tech Specifications

iB Standard	Possible Alternative
-------------	----------------------

Headwork Ceramic Headwork G 3/8" Flow Restrictions – See below

Wall Hoses Flexible Inox 3/8", 400 mms long Flexible Inox 1/2", 400 mms long
Copper Tails
PEX Pipes

Different lengths available on request

Flow Rate
(+/- 10%)

1 BAR	16,21 l/m
2 BAR	23,15 l/m
3 BAR	28,5 l/m

Changing aerator or adding flow restrictors in the hoses, the following range of TOP flow rates can be achieved	4,0 l/m
	8,0 l/m
	12,0 l/m
	16,0 l/m
	20,0 l/m
	28,0 l/m

Material Brass
According to CUZN35PB2AL-B(CB752S)

Max Lead content: 1,6%

Production Main body is a single casted piece



info@ibrubinetterie.it
p.iva 01785230986
capitale sociale €420.000,00 i.v.
T +39 030 802101
F +39 030 803097
iB Rubinetterie SpA
via dei pianotti, 3/5 - 25068 sarezzo (bs) - Italy

Elenco parti

ELEM	CODICE	NUMERO DI MAGAZZINO	QT
1	CC0002160	Lever	2
2	AQ0004180	OR 9.25x1.78 NBR 70 SH	2
3	AC0010487	Nut cover	2
4	AQ0004630	OR 17.16x1.78 NBR 70 SH	2
5	AQ0010617	Click connection for headworks with ring	2
6	AQ0010516	Ceramic headwork G3/8" SX	1
7	AQ0010515	Ceramic headwork G3/8" DX	1
8	CC0001885	Traditiona mixer basin body two lever	1
9	AQ0000932	Inox hose	2
10	AQ0010357	Fixing set	1
11	AQ0009837	Waste	1

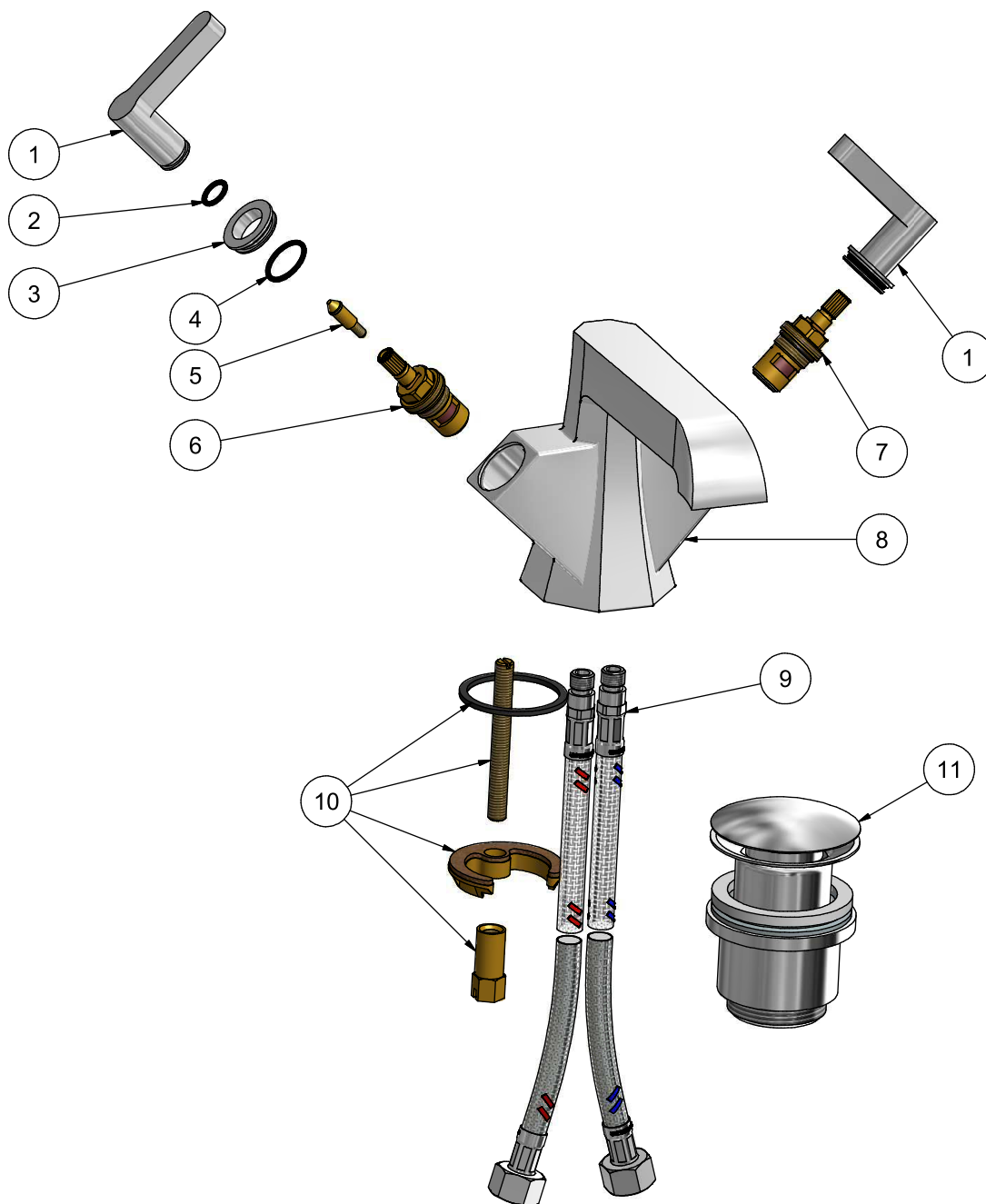
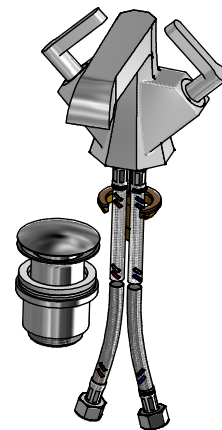

A termini di legge questo disegno non può essere riprodotto senza la nostra autorizzazione

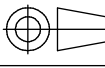
 www.ibrubinetterie.it Via del Pianotti 3/5 25068 Sarezzo - BRESCIA tel. 030802101 fax. 030803097 www.ibrubinetterie.it	Tolleranze generali		Peso	Scala	Formato ISO A3	
	Materiale					
	Disegnatore Vivenzi M.	Data creazione 20/06/2006	Approvato da	Approvato il		
	Denominazione Esplso Monoforo lavabo - leva				Codice KBL205CCXN_1	

WARRANTY

all iB Rubinetterie SpA products are warranted for 10 years from the date of purchase, for the following cases:

- defects of casting, porosity and chrome plating
- operating defects caused by incorrect fabrication.

The warranty provides for the repair or replacement of products with fabrication defects recognized by our technical office.

There is no other type of compensation and the merchandise must be returned FOB our warehouse. The warranty only cover surface defects (scartches, dings, etc.) on fittings that have not been installed and used, returned in its original packaging with all components.

O-rings, gasket seals and components subject to wear proportional to use are warranted for 2 years.

The warranty is void in the following cases:

- error installing and putting the product into service.
- deterioration of chrome-plated surfaces due to use of cleaning products containing acids or abrasive substances
- deterioration of surface with finishes other than chrome plating. Their durability is, in fact, dependent on the user's care and gentleness of use.
- deterioration of the fitting due incorrect installation.
- improper repairs and maintenance performed without the company's prior authorization.

The warranty from iB Rubinetterie SpA is not renewable.

Cleaning:

We recommend cleaning chrome-plated and gold-finish surface with water and soap, using a soft cloth.

Do not use detergents that contain hydrochloric acid or abrasive substances.

Plastic parts must only be cleaned with soap and water and soft cloth.

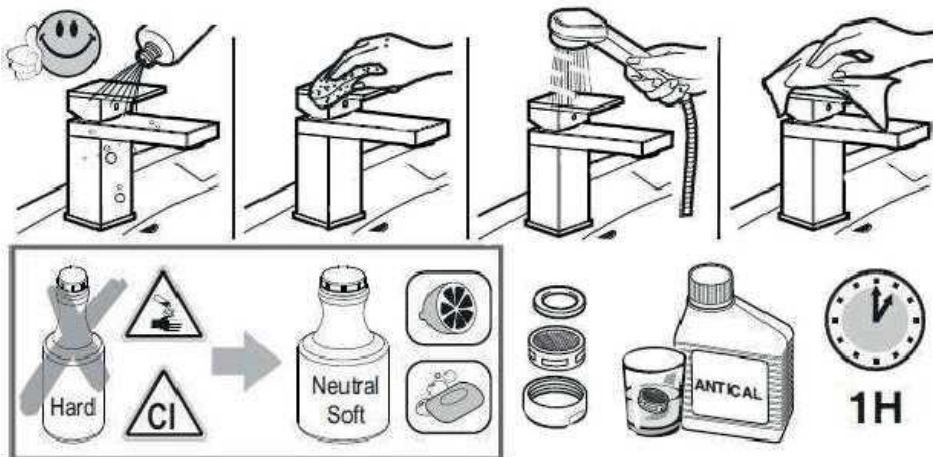

IMPORTANT

Pressure & Temperature Requirements.

- * Hot and cold water inlet pressures should be equal.
- * Inlet pressure range: 150-1000 kPa
- * New Regulation: -500 kPa maximum operating pressure at any outlet within a building. (Ref. AS/NZS 3500.1-2003, Clause 3.3.4)
- * Maximum hot water temperature: 80°C.



iB Rubinetterie S.p.A.
Via dei Pianotti 3/5
25068 SAREZZO (BS) Italy
Iscr. Reg. Impr. BS 01785230986
R.E.A. BS 352087
P.IVA IT01785230986
Capitale Sociale € 420.000,00 i.v.
phone +39 030 802101
fax +39 030 803097
info@ibrubinetterie.it
www.ibrubinetterie.it

